

Model : XT4265S

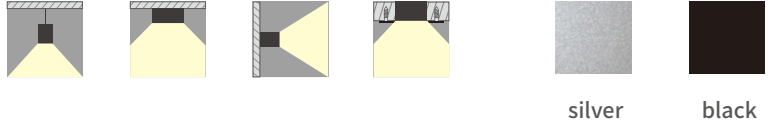

Description

1. Same length cutting for Aluminum channel and PC cover , there is no need to reserve a space for end cap
2. One complete plug, light leakage prevention design
3. Corner fitting connection: — -type, L-type, T-type, X-type
4. Internal power supply installation
5. With reflector increase efficacy by 10%
6. IP20/IP44/IP65 for option
7. UGR < 19
8. The power can be reached for 30W/m
9. Suitable for office, school, hospital, garage lighting

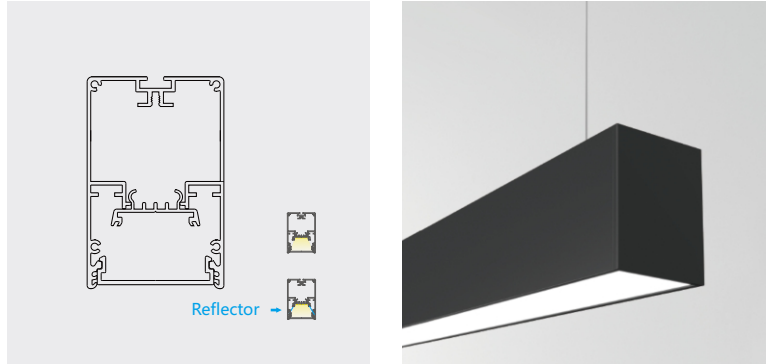

Order steps & code description

XT
4265
S
II
A
S
P
DW
8
D

1
2
3
4
5
6
7
8
9
10

- 1 Smart linear lighting system
- 2 Size for profile
- 3 The type of system
 - Free line system S
 - Free arc system A
- 4 Second generation
- 5 Length
 - 1.0m A
 - 1.2m B
 - 1.5m C
 - 1.8m D
 - 2.0m E
 - 2.5m F
- 6 Color
 - silver S
 - black B

(*Power=30W x n)

Choose 1-6 ,only for profile order

- 7 Lighting board
 - PCB P
 - FPC F
- 8 Color temperature (CCT)
 - 2700K KW
 - 3000K WW
 - 4000K NW
 - 6000K CW
- 9 Color rendering index (Ra)
 - CRI 80 8
 - CRI 90 9
- 10 The type of power supply
 - Dimming D
 - No dimming ND

Choose 1-10 ,only for luminaire order

Eg: A. Profile order code [XT4265SES](#) / B. Luminaire order code [XT4265SCPDW8ND](#)

XT4265S

Structure description

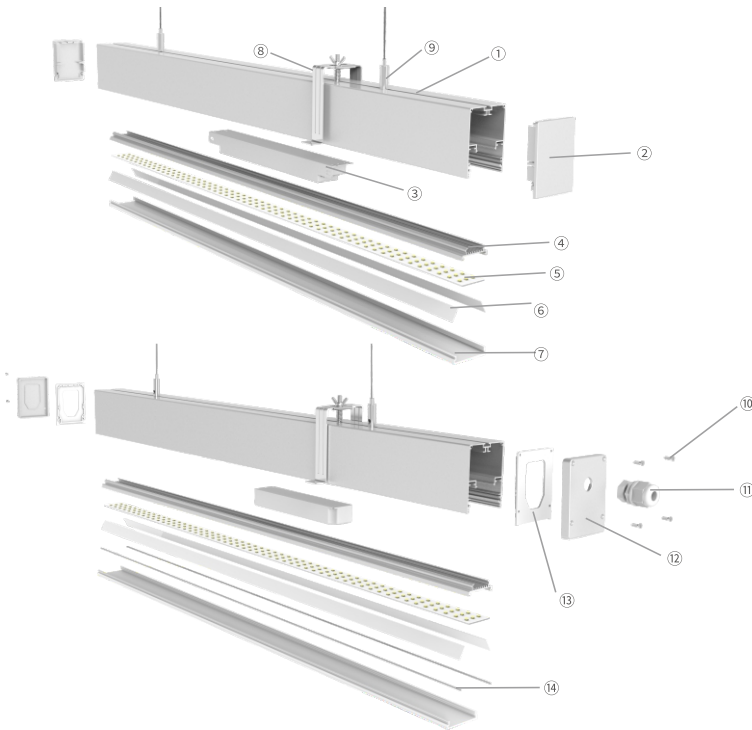

- ① Profile
- ② End cap
- ③ Power supply
- ④ Heat sink
- ⑤ Lighting source
- ⑥ Reflective paper
- ⑦ Cover
- ⑧ Trim less Embed buckle
- ⑨ Pendant
- ⑩ Screw
- ⑪ Waterproof PG
- ⑫ PC end cap
- ⑬ End cap waterproof ring
- ⑭ Silicone band

Profile

Installation :	Pendant/ Surface mounted/ Wall mounted/ Recessed
Material :	Aluminium 6063-T5
Available lengths:	1.0/1.2/1.5/1.8/2.0/2.5m
Application :	Commercial lighting /Office lighting
IP :	IP20/IP44/IP65

Cover

Cover :	PC
Available lengths:	1.0/1.2/1.5/1.8/2.0/2.5m
Transmittance:	85%

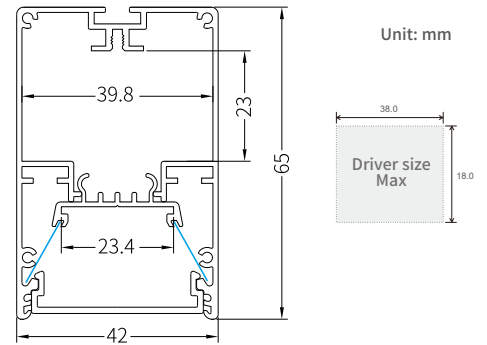

XT4265S

Lighting source

- ① PCB/FPC two types of models can be selected
- ② Constant voltage/current can be cutting
- ③ **Efficacy>120lm/W**
- ④ SDCM<3
- ⑤ Ra>80、Ra>90(R9>0)

Match with (1.0/1.2/1.5/1.8/2.0/2.5m) length of luminaire

NJG-23X500X1 12C6B

PCB-Constant current
Power: 30 W/m
Width: 0.023m
length : 0.49m/pcs



Match with (1.0/1.2/1.5/1.8/2.0/2.5m) length of luminaire

NJG-C8200-20-5C20B

FPC-Constant voltage
Power: 20 W/m
Width: 0.018m
length : 5.0m/reel



Power supply (driver)

- ① **Internal/External** dimming driver
- ② Constant current dimming / no dimming
- ③ 0/1-10V、Dali dimming
- ④ Wireless access control, installation without add new wires
- ⑤ Building overall/partition dimming, luminous environment intelligent control



Power: 30 W
Size: 205*30*22mm
Dimming: 0/1-10V、Dali
Input voltage: 100-277VAC
Output voltage: 27-42VDC
Output current: 650mA
Efficiency: 90% max
Power factor: > 0.9

XT4265S

Installation

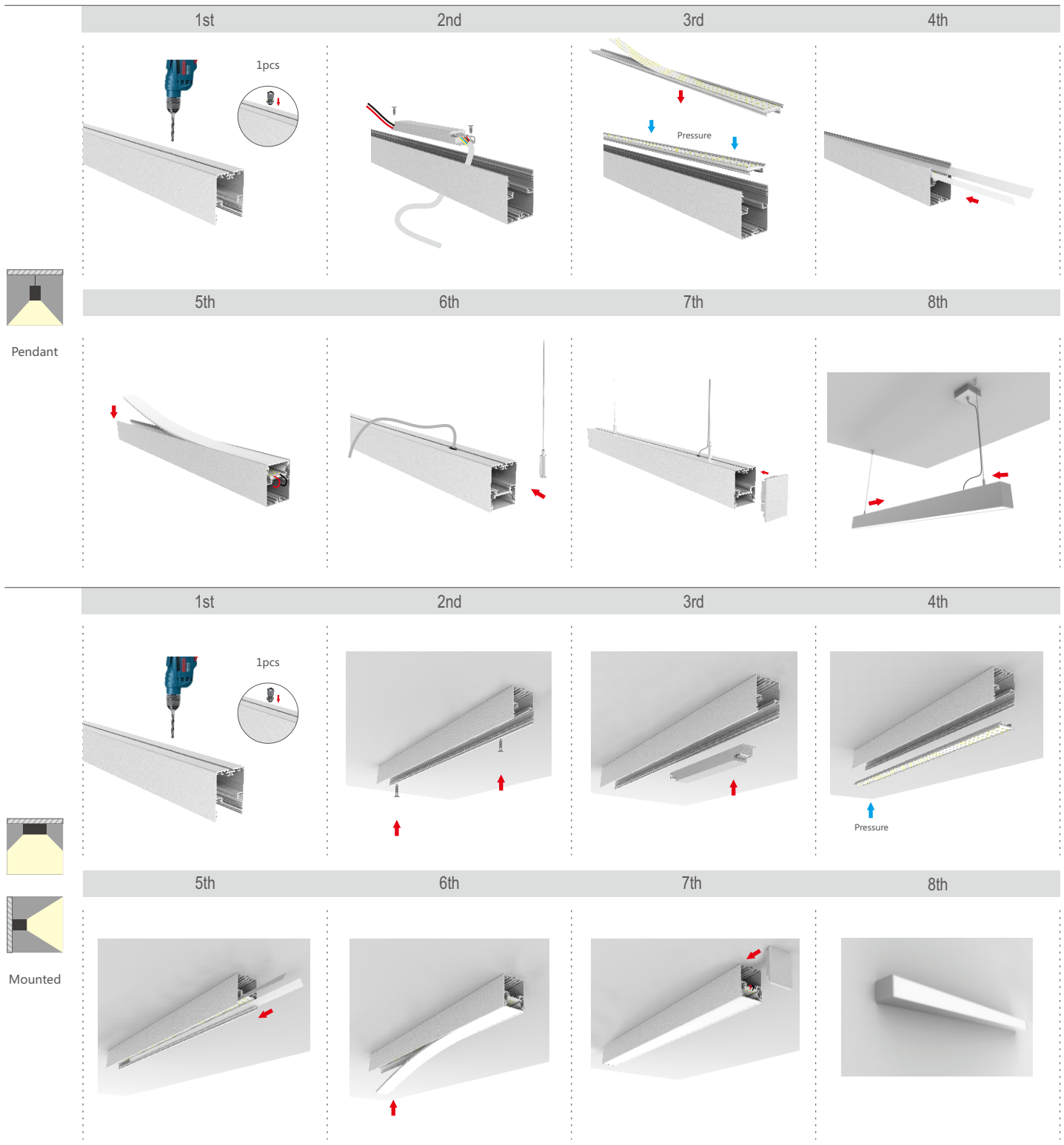

XT4265S

Installation

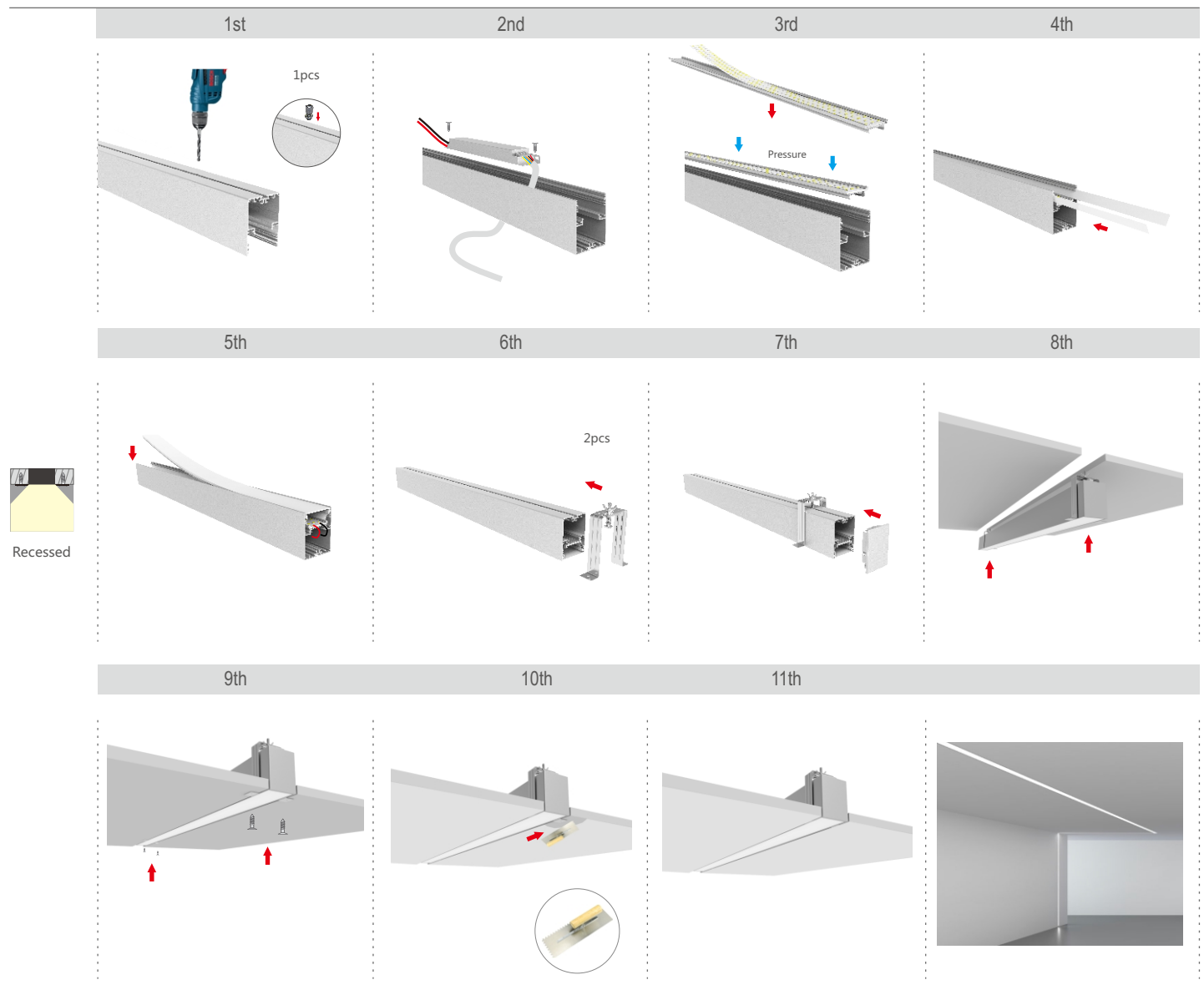





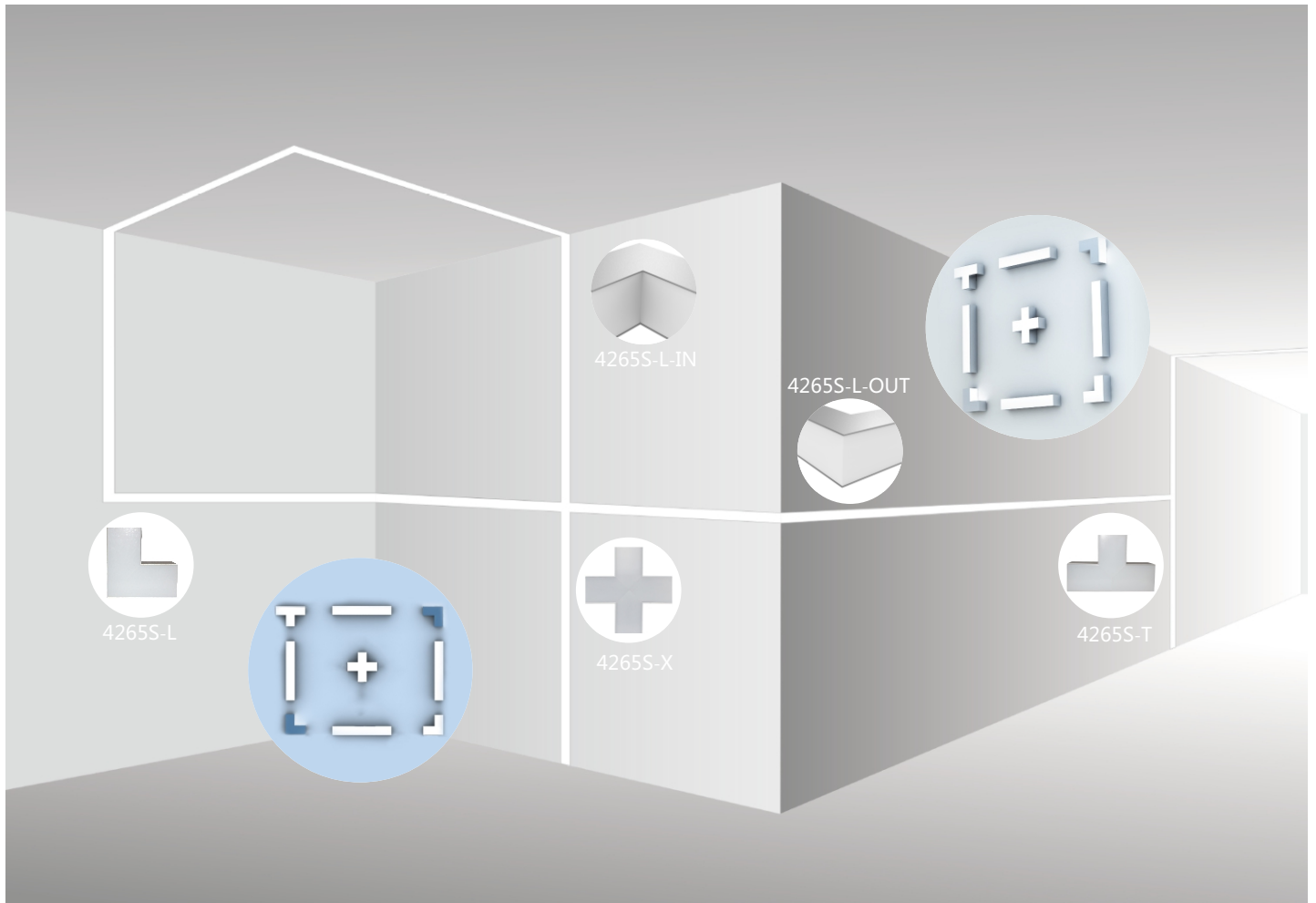









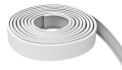



XT4265S

Connector











XT4265S

Order Guide

Order code	Name	Picture	Discription	Size	Surface treatment	Color
XT4265S001	4265S kit		Profile+heat sink +cover	42*65*2500mm	Anodized	Silver/Black
XT4265SPRO	Profile		AL 6063-T5	2500mm	Anodized	Silver/Black
XT4265SHSK	Heat sink		AL 6063-T5	2500mm	Anodized	Silver
XT4265SCOV	Cover		Anti-fire PC	2500mm	Diffuser	-
XT4265SC20	Cover		Anti-fire PC	20m	Diffuser	-
XT4265S002A	End cap		PC	42*65mm	Painting	Silver/Black
XT4265S002B	End cap kit		PC	42*65mm	Painting	Silver/Black
NJG-23X500-12C6B	PCB		Efficacy:> 120lm/W P: 30W/m,Ra>80	Width: 23mm	499mm/pcs for 1.0/1.2/1.5/1.8/2.0/ 2.5m luminaire	White
NJG-C8200-20-5C20B	FPC		Efficacy:> 120lm/W P: 24V-19.2W/m,Ra>80	Width: 18mm	5.0m/reel	White
XT4265SZJT	4265S-T		standard part	-	-	Silver/Black
XT4265SZJX	4265S-X		standard part	-	-	Silver/Black
XT4265SZJL	4265S-L		standard part	-	-	Silver/Black
XT4265SZJI	4265S-L-IN		standard part	-	-	Silver/Black
XT4265SZJO	4265S-L-OUT		standard part	-	-	Silver/Black
XTXXXXSJXH	Terminal box		Anti-fire PC	80*80*38mm	Painting	Silver
XTXXXXSNQB	Embed buckle		Stainless steel	-	Electroplating	Silver
XTXXXXSDZJ	Pendant kit		Steel wire、copper	2000mm	Electroplating	Silver
XTXXXXSPJT	Splicing kit		Connector+screw	45*9.3*2.0mm	Electroplating	Silver

XT4265S

XTXXXSPJLA	Splicing kit		Connector+screw	-	Electroplating	Silver
XTXXXSPJLA	Splicing kit		Connector+screw	-	Electroplating	Silver
XTXXXGJT	Silicone band		Ø=2.5mm	-	-	Transparent
XTXXXHXB				-	-	-
XT4265SPGM	Polarizing film		PVA	-	-	Gray
XT4265YHB	Embossing plate		PMMA	-	-	Transparent
XTXXXFGP	Reflector	 	Increase efficacy by 10%	-	Smooth	White
