



Model : XT9627S



silver

black

Description

1. Same length cutting for Aluminum channel and PC cover , there is no need to reserve a space for end cap
2. One complete plug, light leakage prevention design
3. Corner fitting connection: — -type, L-type, T-type, X-type
4. External power supply installation
5. With reflector increase efficacy by 10%
7. UGR < 19
7. The power can be reached for 60W/m
8. Suitable for office, school, hospital, garage lighting

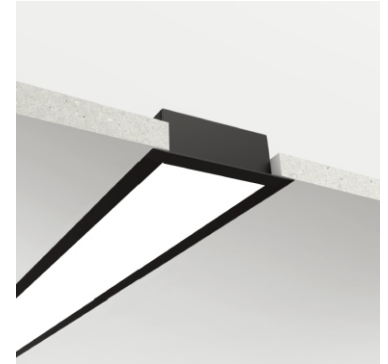
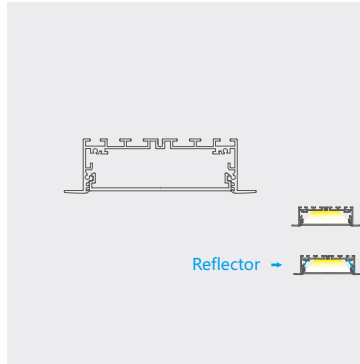

Order steps & code description

XT
9627
S
II
A
S
P
DW
8
D

1
2
3
4
5
6
7
8
9
10

- ① Smart linear lighting system
- ② Size for profile
- ③ The type of system
Free line system S
Free arc system A
- ④ Second generation
- ⑤ Length
n
1.0m A
1.2m B
1.5m C
1.8m D
2.0m E
2.5m F
- ⑥ Color
silver S
black B

(*Power=60W x n)

- ⑦ Lighting board
PCB P
FPC F
- ⑧ Color temperature (CCT)
2700K KW
3000K WW
4000K NW
6000K CW
- ⑨ Color rendering index (Ra)
CRI 80 8
CRI 90 9
- ⑩ The type of power supply
Dimming D
No dimming ND

Choose 1-6 ,only for profile order

Choose 1-10 ,only for luminaire order

Eg: A. Profile order code [XT9627SES](#) / B. Luminaire order code [XT9627SCPDW8ND](#)

XT9627S

Structure description

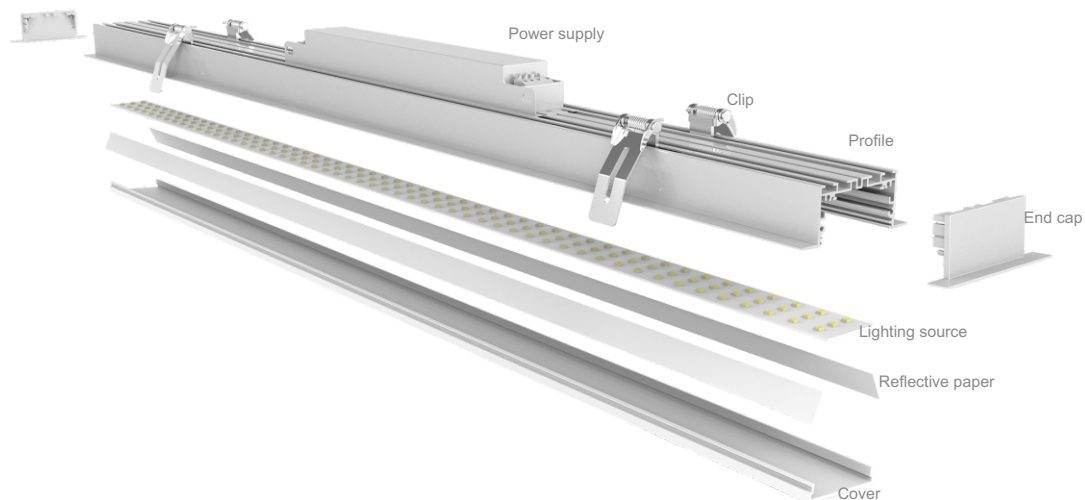

Profile

Installation :	Ceiling/Wall & ground embed / Recessed
Material :	Aluminium 6063-T5
Available lengths:	1.0/1.2/1.5/1.8/2.0/2.5m
Application :	Commercial lighting /Office lighting
IP :	Ip20

Unit: mm

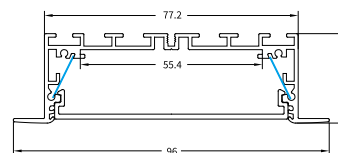

Cover

Cover :	PC
Available lengths:	1.0/1.2/1.5/1.8/2.0/2.5m
Transmittance:	85%

XT9627S

Lighting source

- ① PCB/FPC two types of models can be selected
- ② Constant voltage/current can be cutting
- ③ Efficacy > 120lm/W
- ④ SDCM < 6
- ⑤ Ra > 80, Ra > 90 (R9 > 50)



Match with (1.0/1.2/1.5/1.8/2.0/2.5m) length of luminaire
NJG-55X500 12C15B

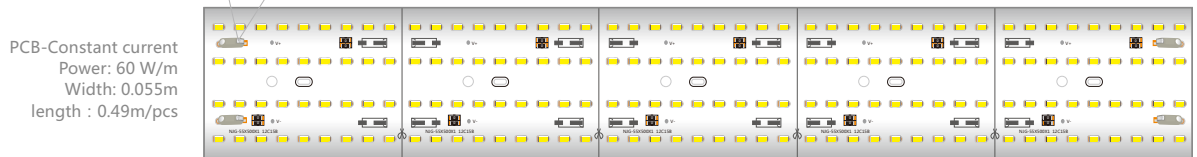

Match with (1.0/1.2/1.5/1.8/2.0/2.5m) length of luminaire
NJG-C8400-58-10C20B

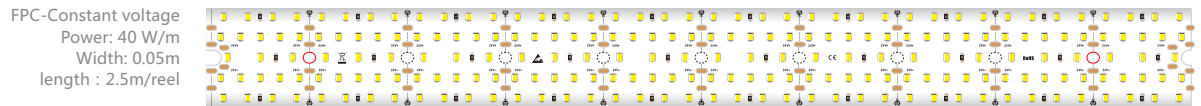

Power supply (driver)

- ① Internal/External dimming driver
- ② Constant current dimming / no dimming
- ③ 0/1-10V, Dali dimming
- ④ Wireless access control, installation without add new wires
- ⑤ Building overall/partition dimming, luminous environment intelligent control



Power: 60 W
Size: 302*30*22mm
Dimming: 0/1-10V, Dali
Input voltage: 100-277VAC
Output voltage: 30-54VDC
Output current: 1400mA
Efficiency: 90% Max
Power factor: > 0.9

XT9627S

Installation

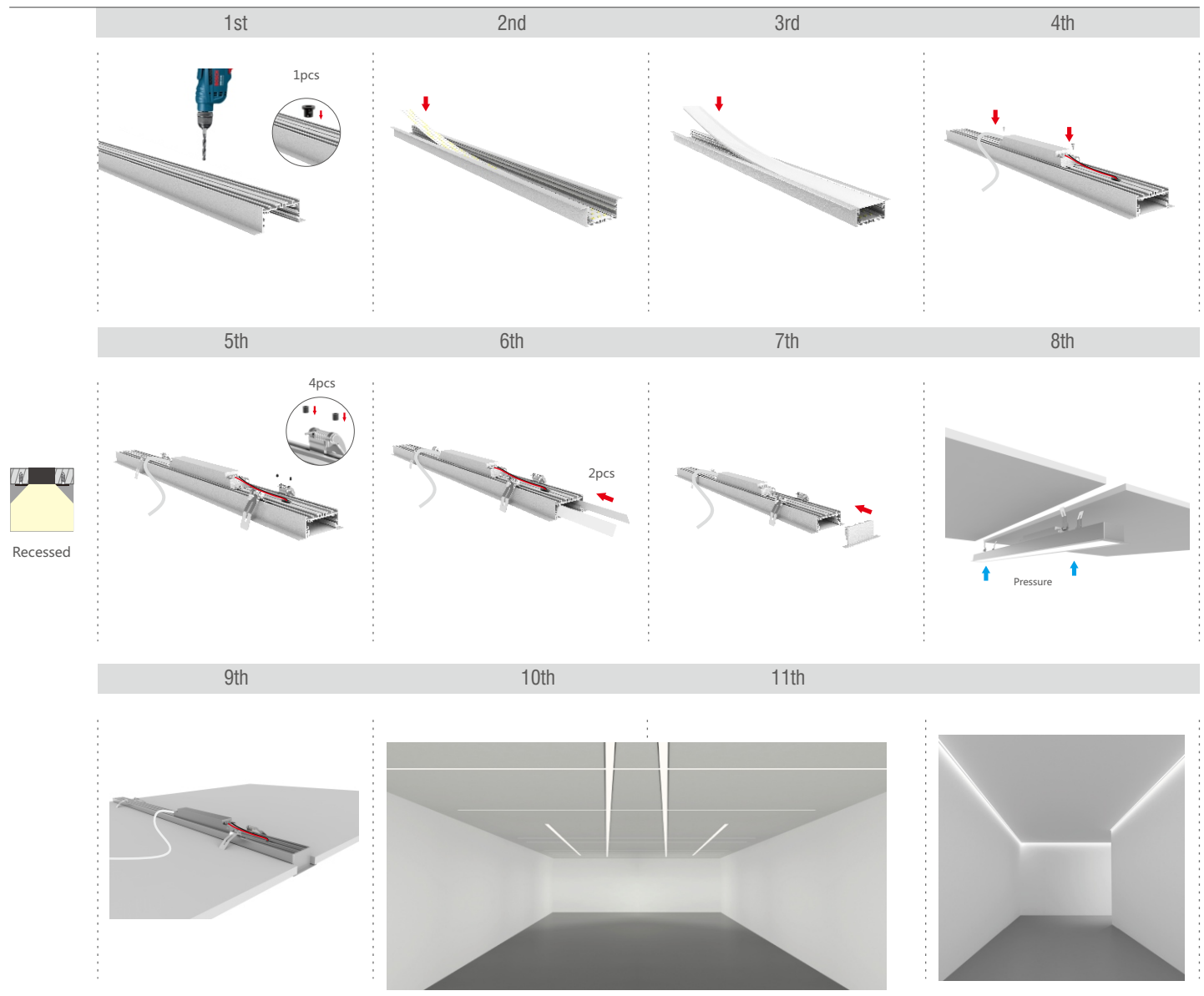





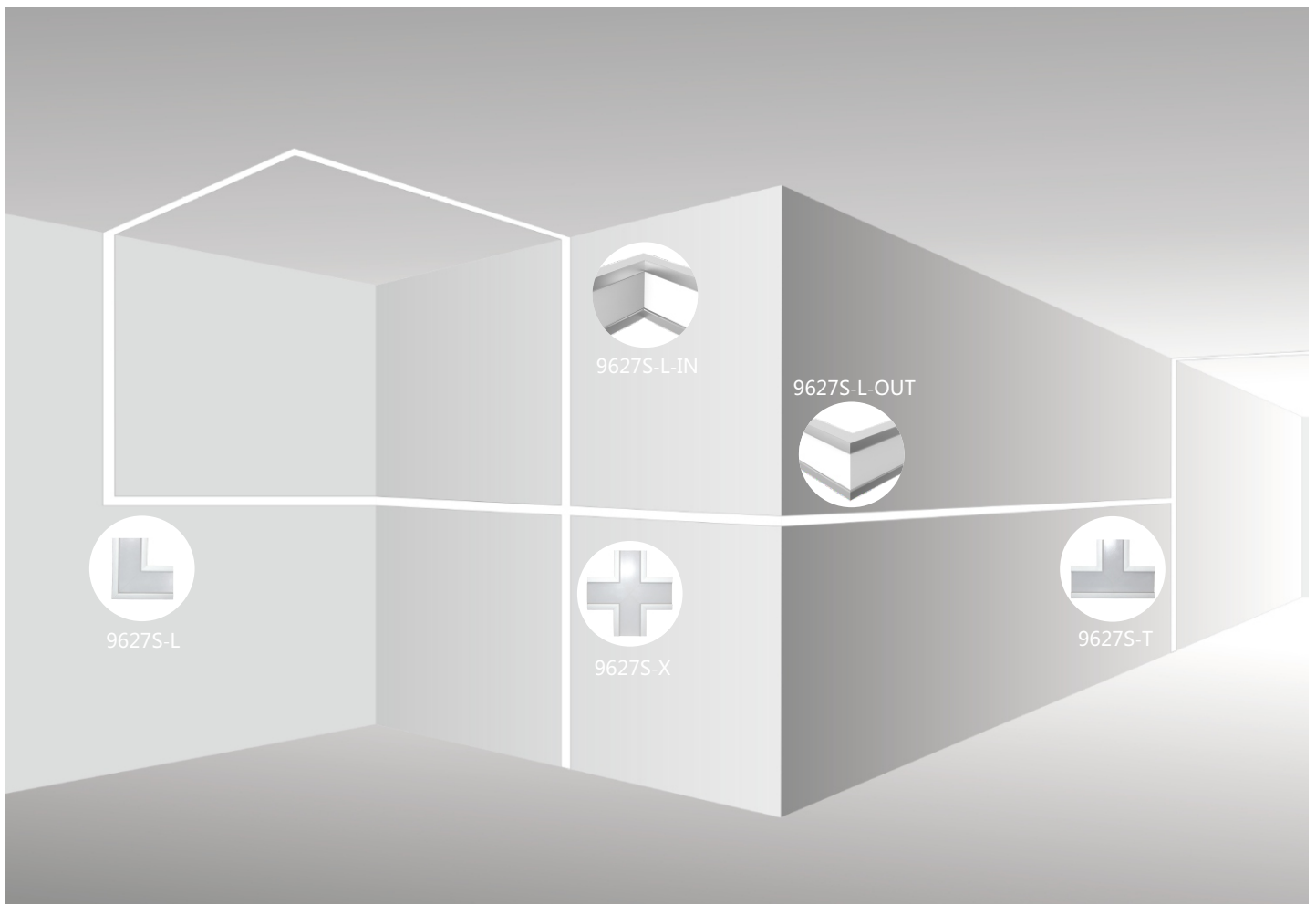



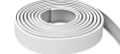

XT9627S

Connector





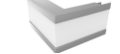



XT9627S

Order Guide

Order code	Name	Picture	Description	Size	Surface treatment	Color
XT9627S001	9627S kit		Profile+ cover	96*27*2500mm	Anodized	Silver/Black
XT9627SPRO	Profile		AL 6063-T5	2500mm	Anodized	Silver/Black
XT9627SCOV	Cover		Anti-fire PC	2500mm	Diffuser	-
XT9627SC20	Cover		Anti-fire PC	20m	Diffuser	-
XT9627S002	End cap		PC	96*27mm	Painting	Silver/Black
NJG-55X500-12C15B	PCB		Efficacy: > 120lm/W P: 60W/m, Ra≥80	Width: 55mm	498mm/pcs for 1.0 /1.2/1.5/1.8/2.0/ 2.5m luminaire	White
NJG-C8400-58-10C20B	FPC		Efficacy: > 120lm/W P: 40W/m, Ra≥80	Width: 50mm	5.0m/reel	White
XT9627SZJT	9627S-T		standard part	-	-	Silver/Black
XT9627SZJX	9627S-X		standard part	-	-	Silver/Black
XT9627SZJL	9627S-L		standard part	-	-	Silver/Black
XT9627SZJI	9627S-L-IN		standard part	-	-	Silver/Black
XT9627SZJO	9627S-L-OUT		standard part	-	-	Silver/Black
XTXXXXSPJT	Splicing kit		Connector+screw+wrench	45*9.3*2.0mm	Electroplating	Silver
XTXXXXHXB	Wire protection		PWB:3X4mm	-	-	-
XTXXXXSHDQ	Embed buckle		Stainless steel	-	Electroplating	-

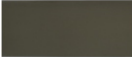
XT9627S

Order Guide

Order code	Name	Picture	Description	Size	Surface treatment	Color
XTXXXXSPJLA	Splicing kit		Connector+screw	-	Electroplating	Silver
XTXXXXSPJLA	Splicing kit		Connector+screw	-	Electroplating	Silver
XT9627SPGM	Polarizing film		PVA	-	-	Gray
XT9627SYHB	Embossing plate		PMMA	-	-	Transparent
XTXXXXFGP	Reflector		Increase efficacy by 10%	-	Smooth	White
NJG-A-60	60W		Uout=30-54V Iout=1400mA P:60W	302*30*22mm	-	White