

## Model : XT9778S



silver



black

### Description

1. **Same length cutting** for Aluminum channel and PC cover , there is no need to reserve a space for end cap
2. One complete plug, **light leakage prevention** design
3. Corner fitting connection: — -type, L-type, T-type, X-type
4. **Internal** power supply installation
5. **With reflector** increase efficacy by 10%
6. **UGR < 19**
7. The power can be reached for **60W/m**
8. Suitable for office, school, hospital, garage lighting

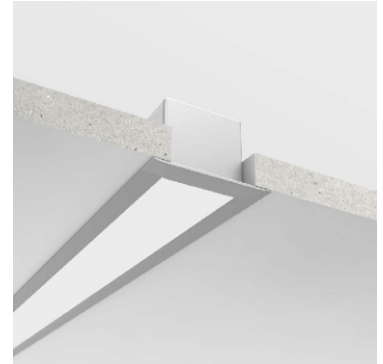
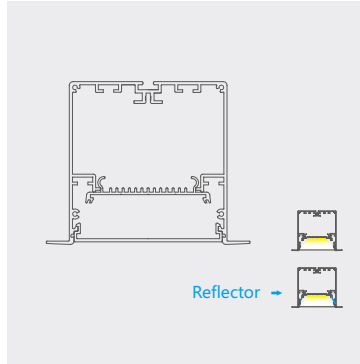

### Order steps & code description

XT
9778
S
II
A
S
P
DW
8
D

1
2
3
4
5
6
7
8
9
10

- |   |                          |  |
|---|--------------------------|--|
| <p>① Smart linear lighting system</p> <p>② Size for profile</p> <p>③ The type of system<br/>Free line system ..... S<br/>Free arc system ..... A</p> <p>④ Second generation</p> <p>⑤ Length<br/>n<br/>1.0m ..... A<br/>1.2m ..... B<br/>1.5m ..... C<br/>1.8m ..... D<br/>2.0m ..... E<br/>2.5m ..... F</p> <p>⑥ Color<br/>silver ..... S<br/>black ..... B</p> | <p>(*Power=60W x n )</p> | <p>⑦ Lighting board<br/>PCB ..... P<br/>FPC ..... F</p> <p>⑧ Color temperature (CCT)<br/>2700K ..... KW<br/>3000K ..... WW<br/>4000K ..... NW<br/>6000K ..... CW</p> <p>⑨ Color rendering index (Ra)<br/>CRI 80 ..... 8<br/>CRI 90 ..... 9</p> <p>⑩ The type of power supply<br/>Dimming ..... D<br/>No dimming ..... ND</p> |
|---|--------------------------|--|

Choose 1-6 ,only for profile order

Choose 1-10 ,only for luminaire order

Eg: A. Profile order code [XT9778SES](#) / B. Luminaire order code [XT9778SCP DW8ND](#)

# XT9778S

## Structure description

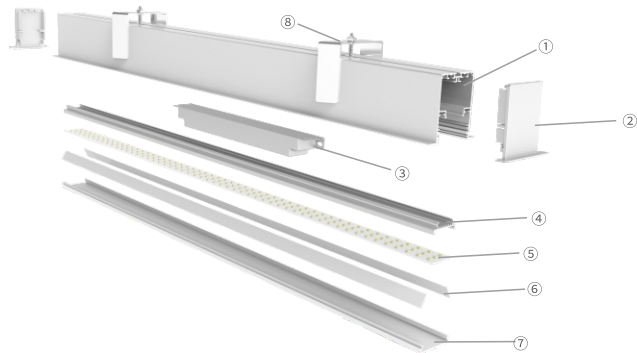

- ① Profile
- ② End cap
- ③ Power supply
- ④ Heat sink
- ⑤ Lighting source
- ⑥ Reflective paper
- ⑦ Cover
- ⑧ Embed buckle

## Profile

Installation :	Ceiling/Wall & ground embed / Recessed
Material :	Aluminium 6063-T5
Available lengths:	1.0/1.2/1.5/1.8/2.0/2.5m
Application :	Commercial lighting /Office lighting
IP :	IP20/IP44/IP65

## Cover

Cover :	PC
Available lengths:	1.0/1.2/1.5/1.8/2.0/2.5m
Transmittance:	85%

Unit: mm

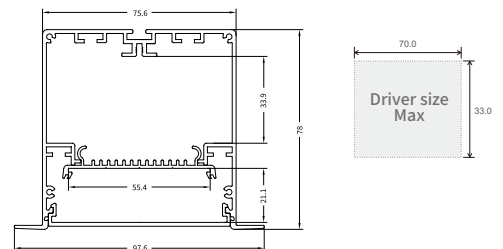

# XT9778S

## Lighting source

- ① PCB/FPC two types of models can be selected
- ② Constant voltage/current can be cutting
- ③ Efficacy>120lm/W
- ④ SDCM<3
- ⑤ Ra>80、Ra>90(R9>0)

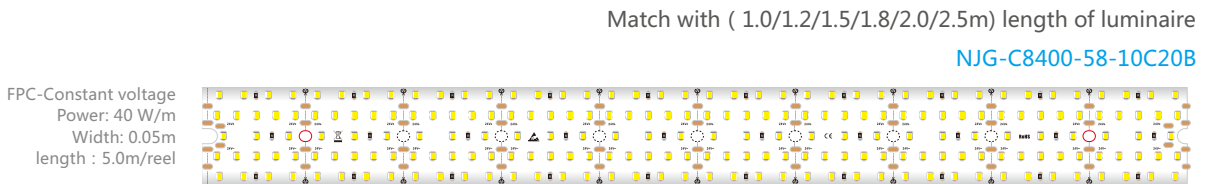
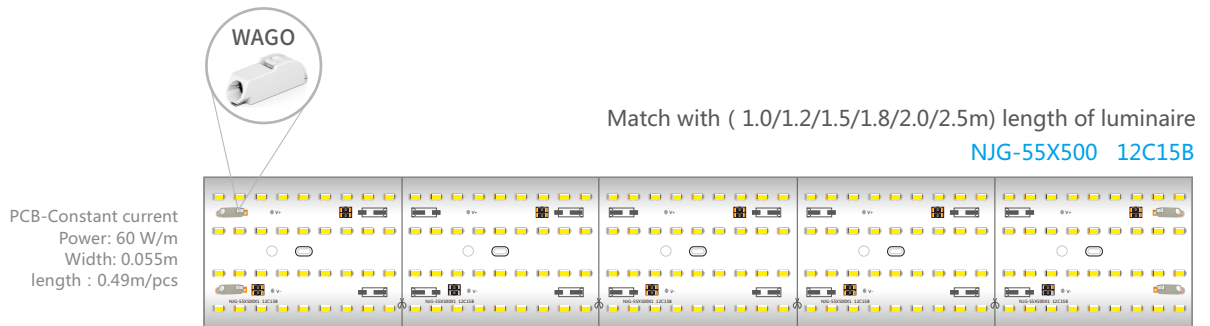

## Power supply ( driver )

- ① Internal/External dimming driver
- ② Constant current dimming / no dimming
- ③ 0/1-10V、Dali dimming
- ④ Wireless access control, installation without add new wires
- ⑤ Building overall/partition dimming, luminous environment intelligent control



Power: 60 W  
Size: 302\*30\*22mm  
Dimming: 0/1-10V、Dail  
Input voltage: 100-277VAC  
Output voltage: 30-54VDC  
Output current: 1400MA  
Efficiency: 90% max  
Power factor: > 0.9

# XT9778S

## Installation

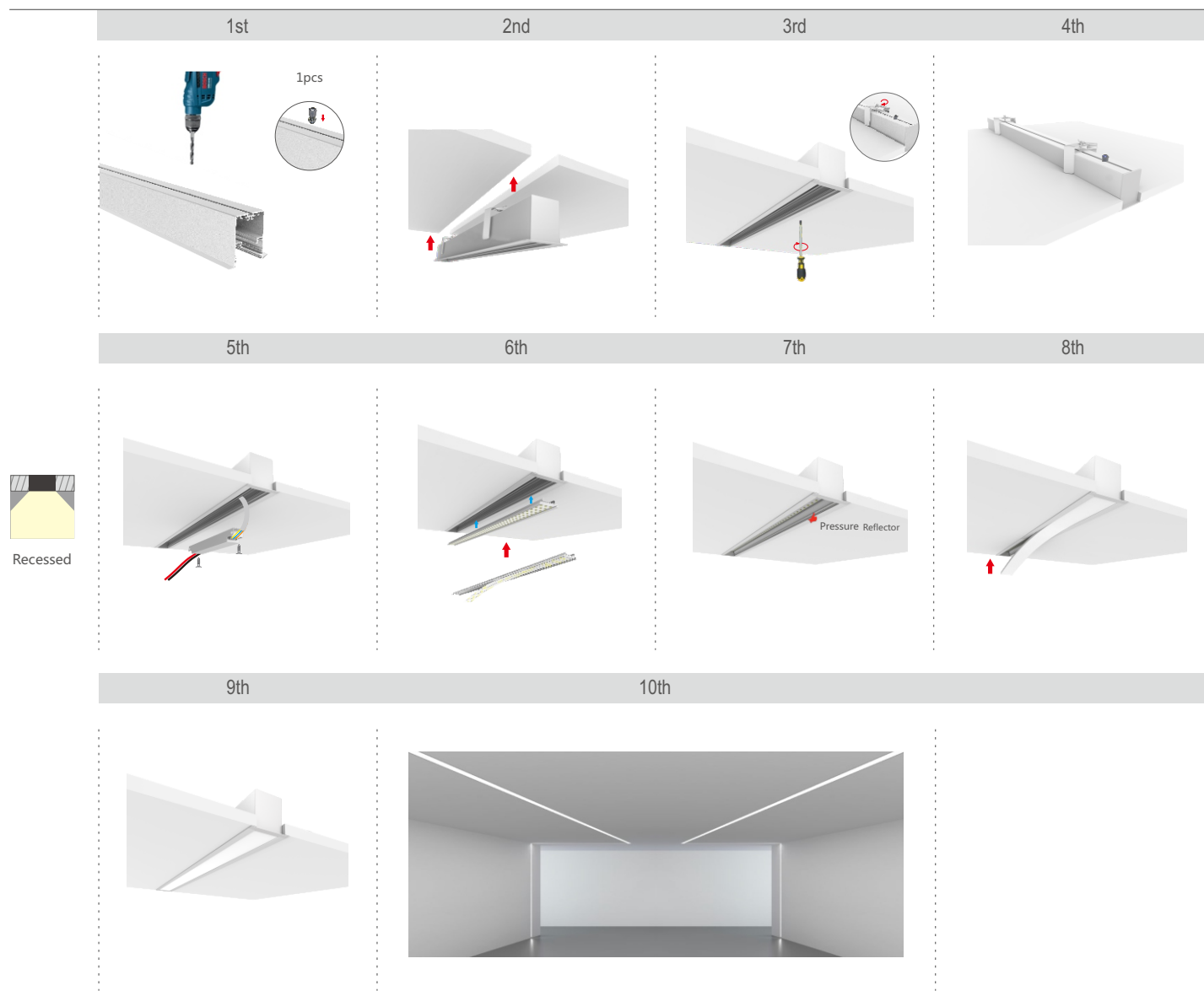





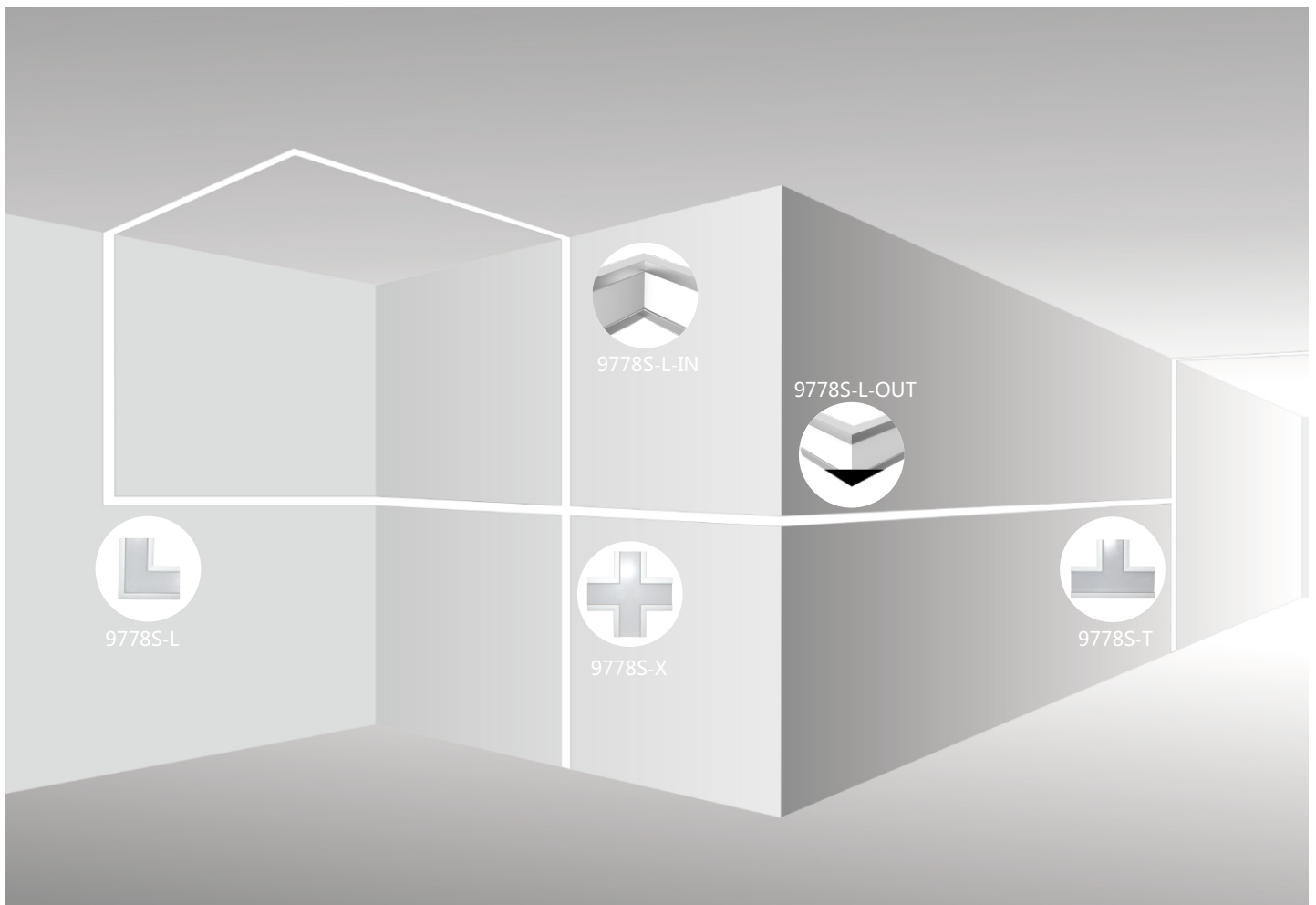









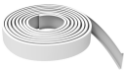

# XT9778S

## Connector









# XT9778S

## Order Guide

Order code	Name	Picture	Description	Size	Surface treatment	Color
XT9778S001	9778S kit		Profile+heat sink + cover	97*78*2500mm	Anodized	Silver/Black
XT9778SPRO	Profile		AL 6063-T5	2500mm	Anodized	Silver/Black
XT9778SHSK	Heat sink		AL 6063-T5	2500mm	Anodized	Silver
XT9778SCOV	Cover		Anti-fire PC	2500mm	Diffuser	-
XT9778SC20	Cover		Anti-fire PC	20m	Diffuser	-
XT9778S002A	End cap		PC	97*78mm	Painting	Silver/Black
NJG-55X500-12C15B	PCB		Efficacy:> 120lm/W P: 60W/m,Ra>80	Width: 55mm	499mm/pcs for 1.0/1.2/1.5/1.8/2.0/ 2.5m luminaire	White
NJG-C8400-58-10C20B	FPC		Efficacy:> 120lm/W P: 40W/m,Ra>80	Width: 50mm	5.0m/reel	White
XT9778SZJT	9778S-T		standard part	-	-	Silver/Black
XT9778SZJX	9778S-X		standard part	-	-	Silver/Black
XT9778SZJL	9778S-L		standard part	-	-	Silver/Black
XT9778SZJI	9778S-L-IN		standard part	-	-	Silver/Black
XT9778SZJO	9778S-L-OUT		standard part	-	-	Silver/Black
XTXXXXSNQK	Embed buckle		Stainless steel	-	Electroplating	Silver
XTXXXXSDZJ	Pendant kit		Steel wire, copper	2000mm	Electroplating	Silver
XTXXXXSPJT	Splicing kit		Connector+screw	45*9.3*2.0mm	Electroplating	Silver

# XT9778S

## Order Guide

Order code	Name	Picture	Description	Size	Surface treatment	Color
XTXXXXSPJA	Splicing kit		Connector+screw	-	Electroplating	Silver
XTXXXXSPJA	Splicing kit		Connector+screw	-	Electroplating	Silver
XTXXXXHXB	Wire protection		PWB:3X4mm	-	-	-
XT9778SPGM	Polarizing film		PVA	-	-	Gray
XT9778SYHB	Embossing plate		PMMA	-	-	Transparent
XTXXXXFGP	Reflector		Increase efficacy by 10%	-	Smooth	White
NJG-A-60	60W		Uout=30-54V Iout=1400mA P:60W	302*30*22mm	-	White